

PARKER

SH136768-TB

Named after famed musician and composer Charlie Parker, Parker's graceful profile and solid brass design are reminiscent of a saxophone's structure. Clean lines add a modern touch, while rounded wire handles make it comfortable to grasp. Features an optional backplate that may be used or removed based on desired aesthetic.

FINISHES

True Black

DIMENSIONS / SPECS

Height: 0.25"
Width/Diameter: 7"
Canopy/Backplate: 1"
Product Weight: 1lb
Extension: 1"
Center-to-Center: 6"
Pull Length: 7"

SHIPPING

Carton 1: 2" x 2" x 2"
Carton 1 Weight: 0lb
Shipping Method: Ground
Country of Origin:

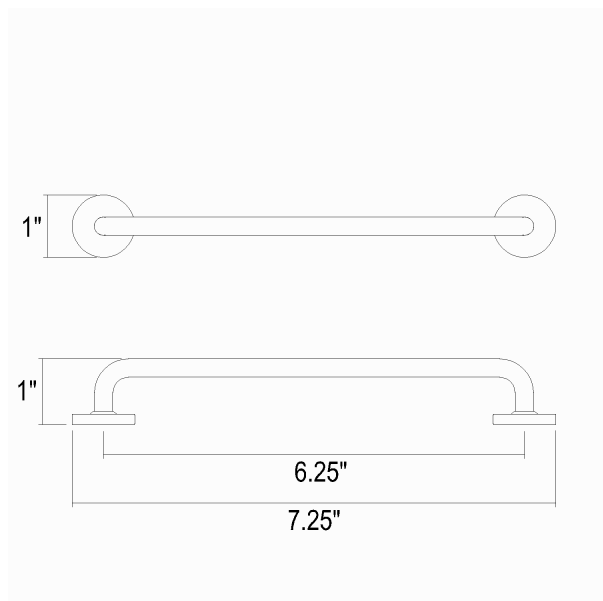

SCHOOLHOUSE